

Single Sliding Shower Screen Installation Guide

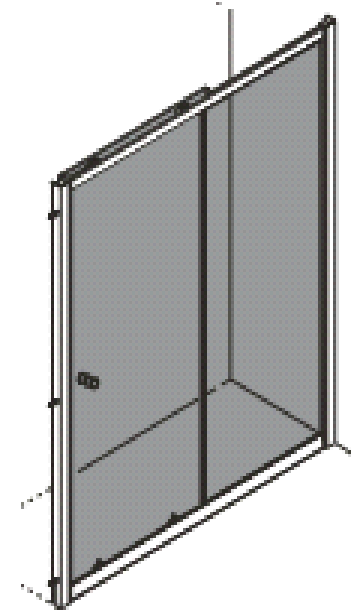

MODEL: SF-F-SLD-11-12

SF-F-SLD-12-13

SF-F-SLD-13-14

SF-F-SLD-14-15

SF-F-SLD-15-16

SF-F-SLD-16-17

SF-F-SLD-17-18

SF-F-SLD-18-19

SF-F-SLD-19-20

SIZE: (1100-1200)X1950

(1200-1300)X1950

(1300-1400)X1950

(1400-1500)X1950

(1500-1600)X1950

(1600-1700)X1950

(1700-1800)X1950

(1800-1900)X1950

(1900-2000)X1950

◆ General Information

Please inspect the product immediately upon receipt for transit damage, missing packs/parts or manufacturing fault. Damage reported after installation will not be accepted. Please handle the product with care avoiding knocks and shock loading to all sides and edges of the glass

Notes: Safety glass can not be re-worked.

Please read these instructions carefully before start of installation.

Special care should be taken when drilling walls to avoid hidden pipes or electrical cables.

Note: This product is heavy and may require two people to install.

Aftercare instructions

After use, your shower should be cleaned with soap and water. This is particularly important in hard water districts where insoluble lime salts may be deposited and allowed to build up.

Cleaners of a gritty or abrasive nature should not be used. Care should be taken to avoid contact with strong chemicals such as organic solvents and strippers.

Glass cleaners can be used but with caution, if in doubt contact the manufacturer of the cleaner in question.

Please keep these instructions for aftercare and customer service details.

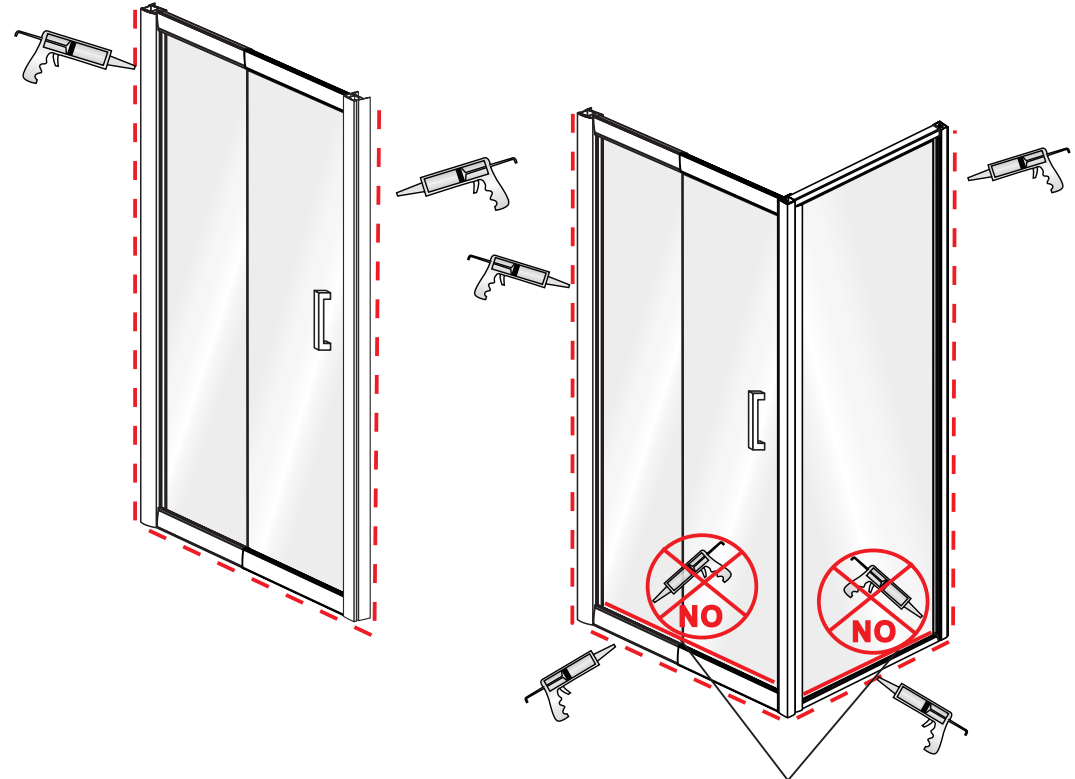
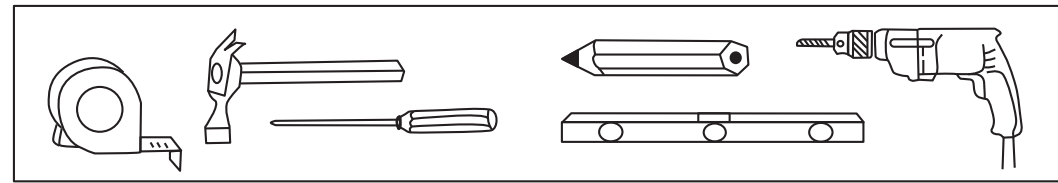

Do not silicone floor section from inside to allow moisture and condensation to drain back into the shower.

Tools Required

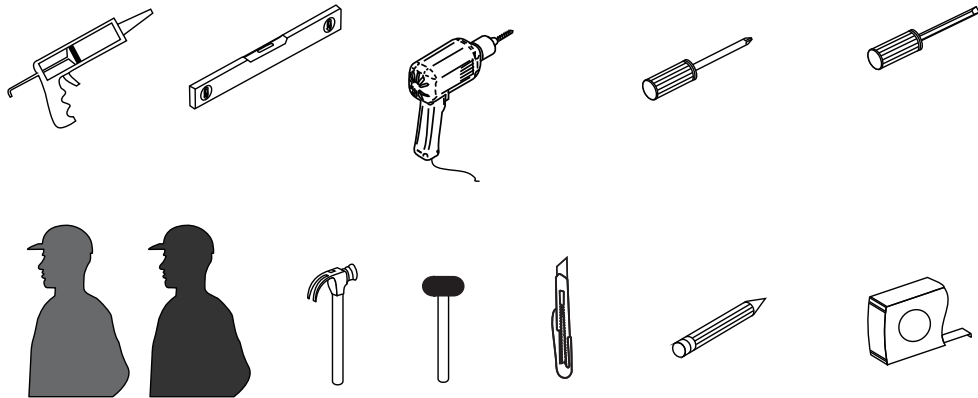

This product is heavy and may require two people to install.



Allow 24 hours for silicone to dry before use.

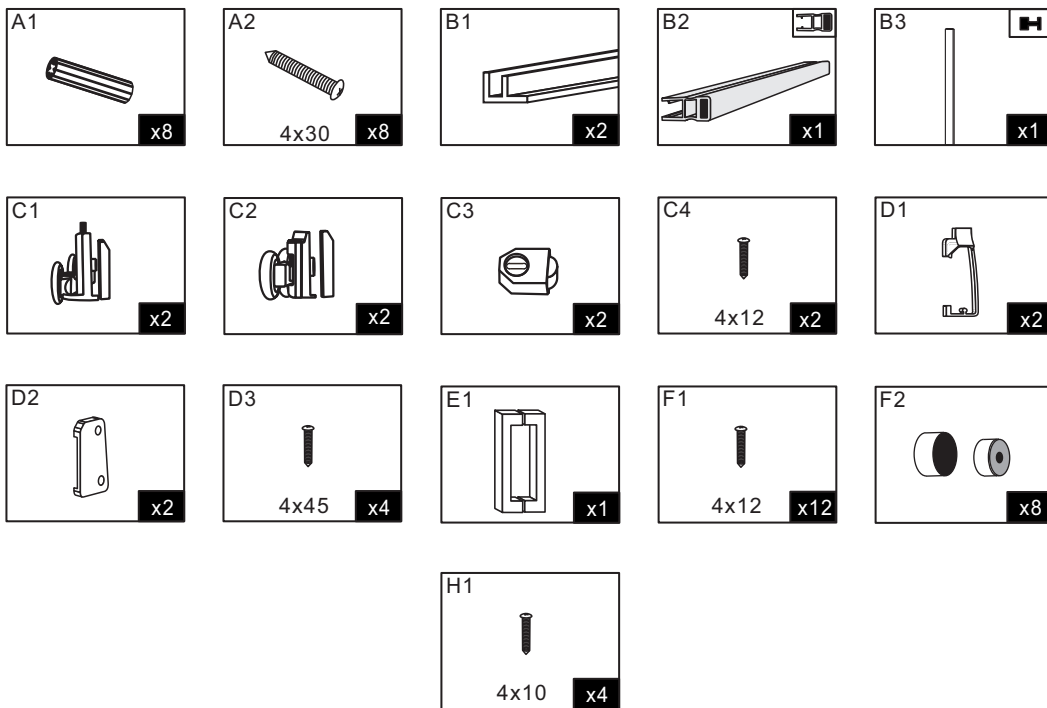
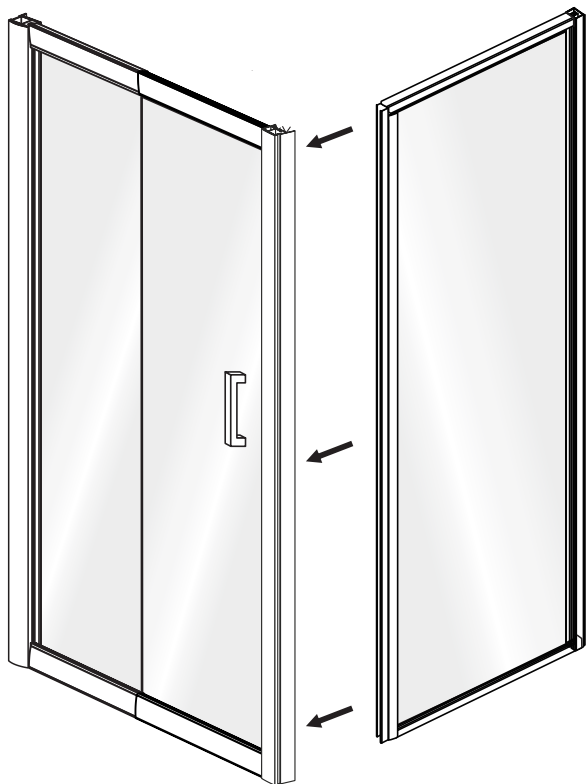
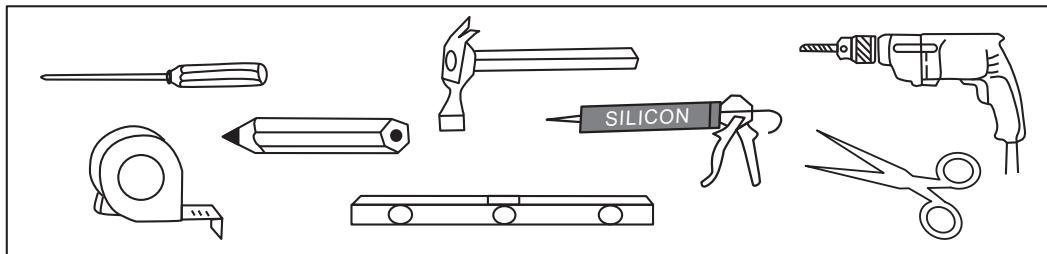
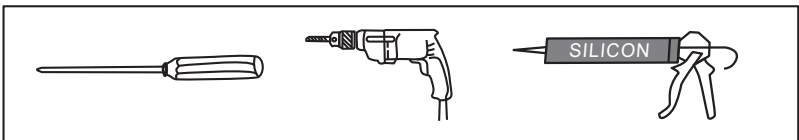

Front and return panel

A1:Wall plug for wall

A2:Screw to fix channel to wall

B1:Plastic seal between Door side/inline panel

B2:Magnetic seal on glass

B3:Magnetic seal to go in side channel

C1:Bottom wheel **(with spring button)**

C2:Top wheel

C3:Door stopper

C4:Screw for door stopper

D1:Plastic cover between inner and out rail (top and bottom)

D2:Plastic connector for channel and rail

D3:Screw for plastic connector (D2)

E1:Door handle

F1:Screw for plastic cap (F2)

F2:Plastic screw cap

H1:Screw to lock the rail (top and bottom)

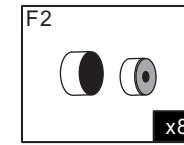
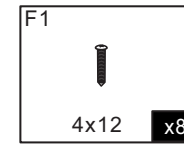
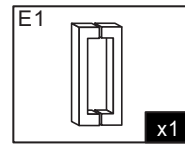
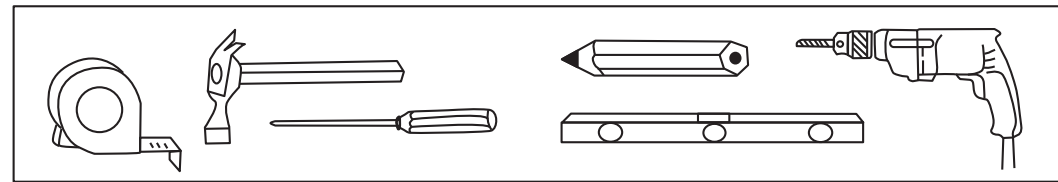

Front only

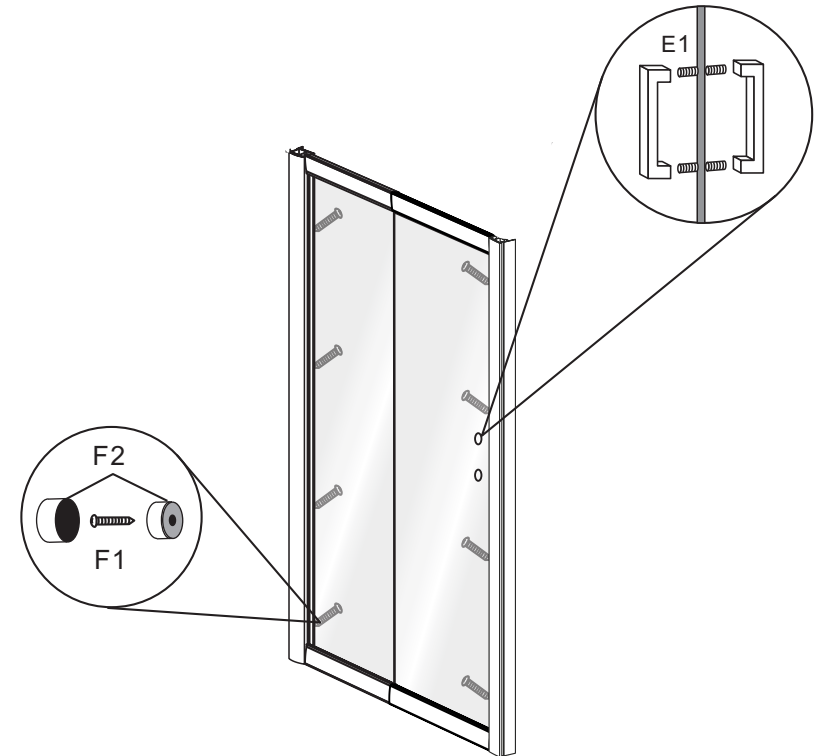

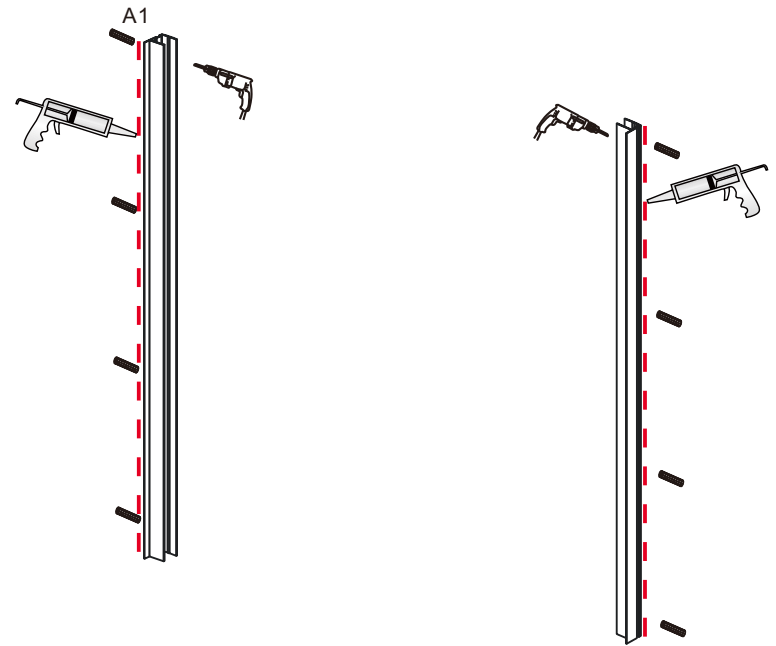
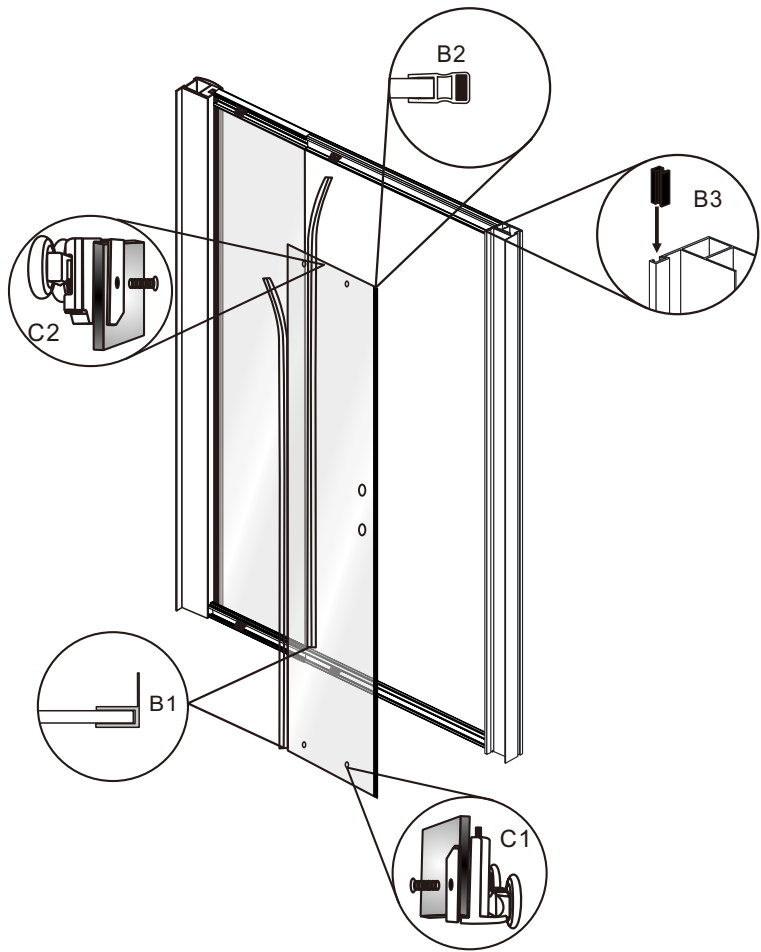
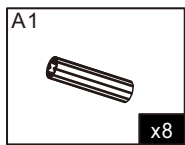
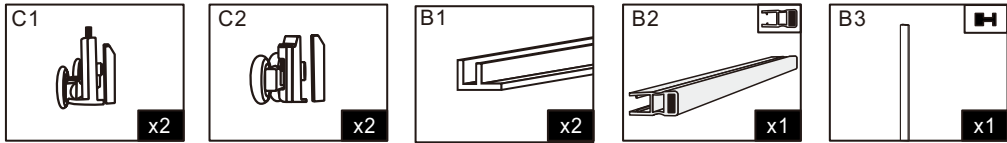
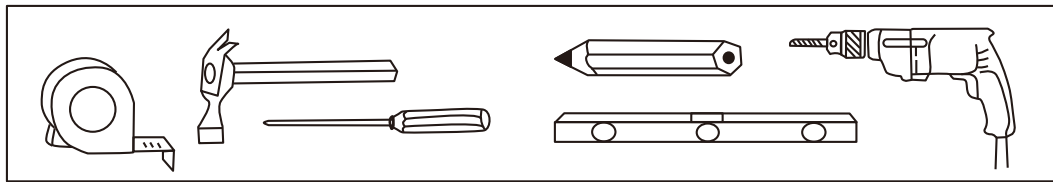
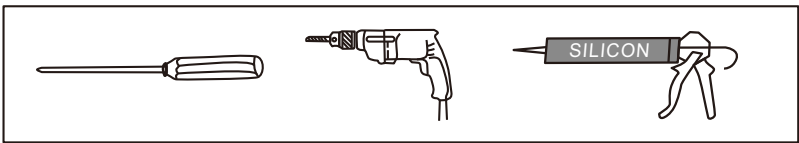

Put silicon behind channel and clean the wall before you install

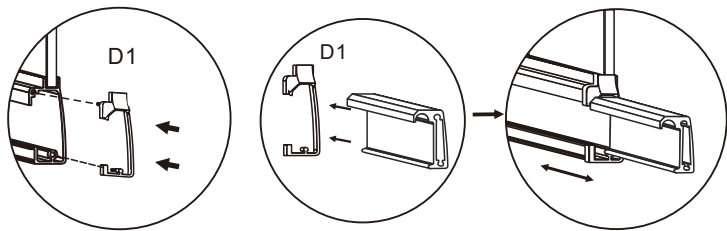
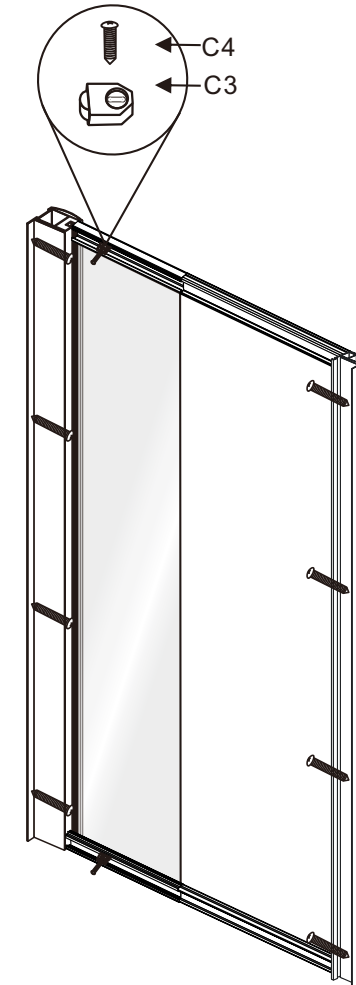
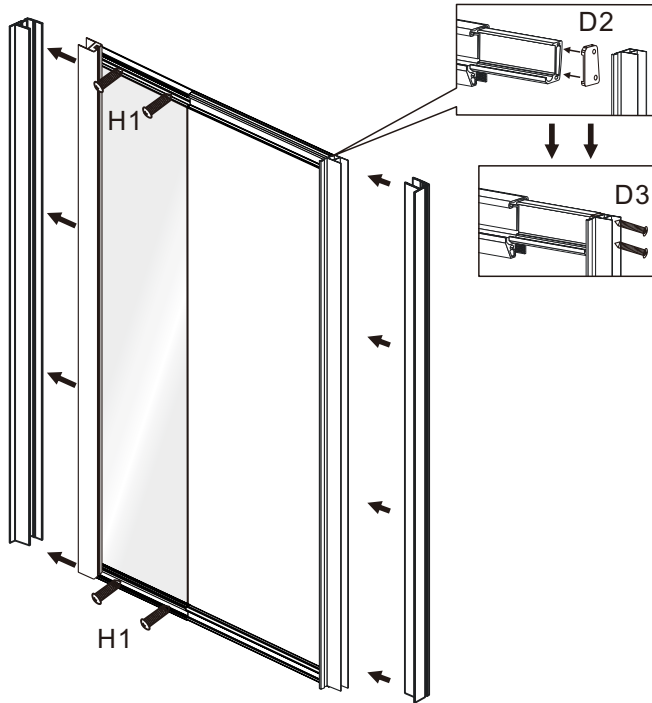
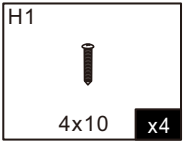
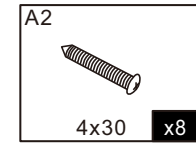
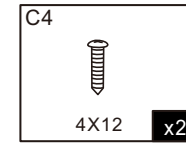
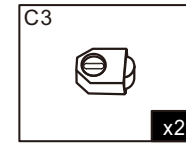
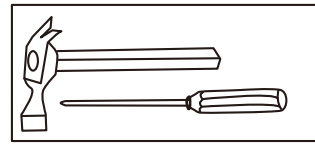
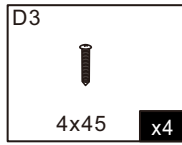
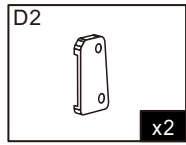
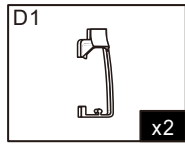
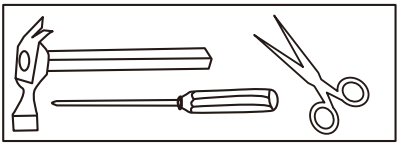

Push the D1 into the aluminum first, make sure the two little bar go into the right position.