

Bath Screen Installation Guide

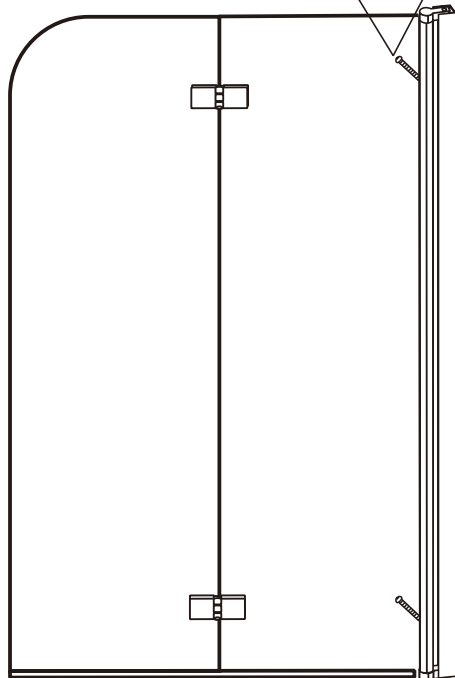
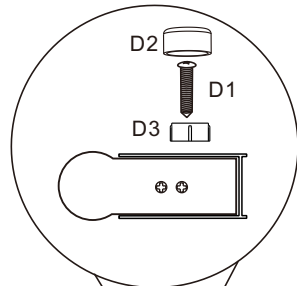
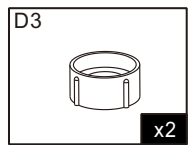
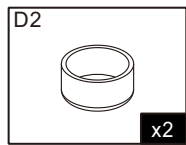
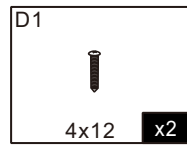
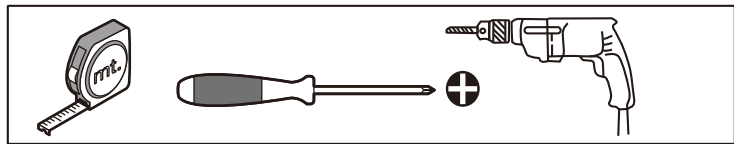

MODEL: BTH-16DD1
SIZE: 1000X1600MM

◆ General Information

Please inspect the product immediately upon receipt for transit damage, missing packs/parts or manufacturing fault. Damage reported after installation will not be accepted. Please handle the product with care avoiding knocks and shock loading to all sides and edges of the glass

Notes: Safety glass can not be re-worked.

Please read these instructions carefully before start of installation.

Special care should be taken when drilling walls to avoid hidden pipes or electrical cables.

Note: This product is heavy and may require two people to install.

Aftercare instructions

After use, your shower should be cleaned with soap and water. This is particularly important in hard water districts where insoluble lime salts may be deposited and allowed to build up.

Cleaners of a gritty or abrasive nature should not be used. Care should be taken to avoid contact with strong chemicals such as organic solvents and strippers.

Glass cleaners can be used but with caution, if in doubt contact the manufacturer of the cleaner in question.

Please keep these instructions for aftercare and customer service details.

Tools Required

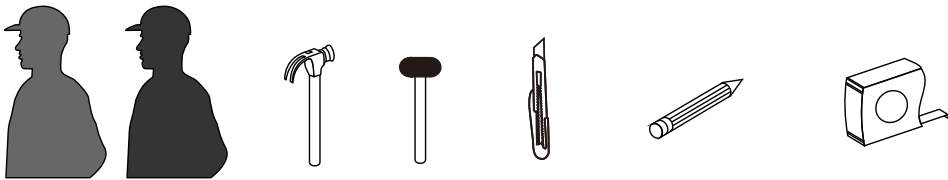
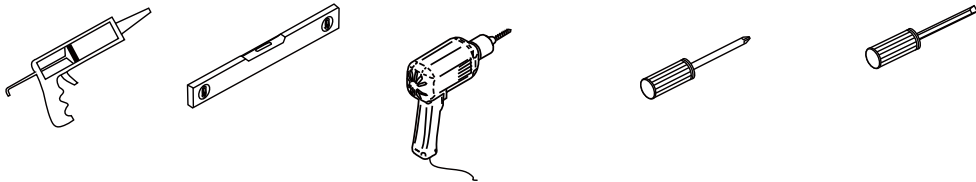

This product is heavy and may require two people to install.

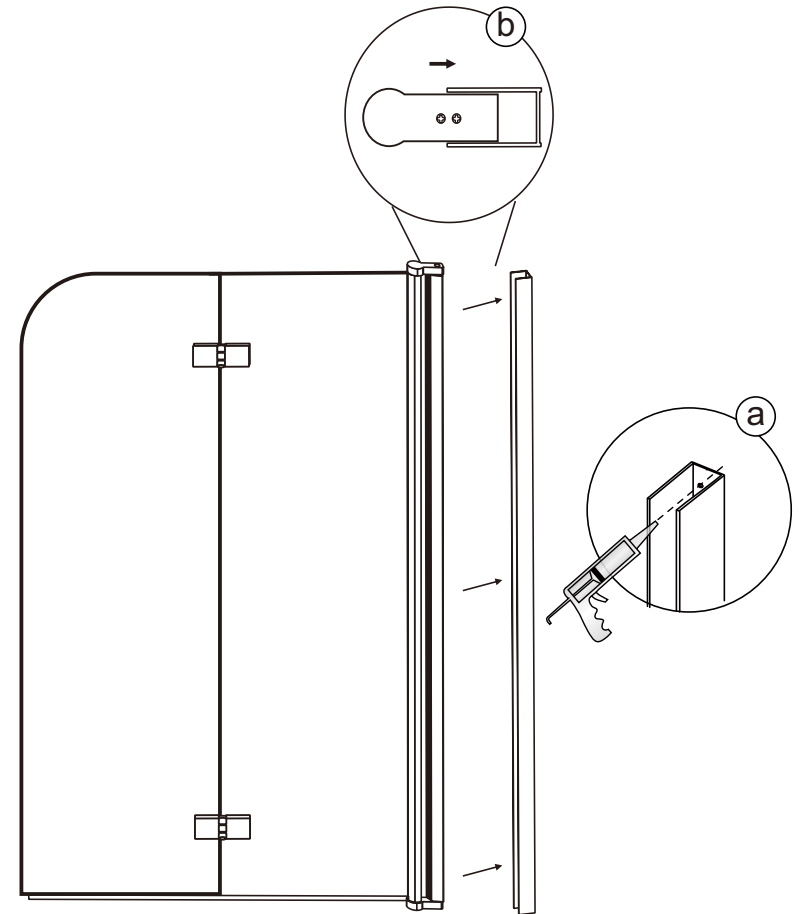

a. Pump Silicon inside the Chanel

b. Put the screen into the Chanel and clean the silicon

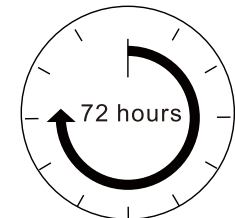

Allow 48 hours for silicone to dry before use.

Allow 72 hours for silicone to dry before use in winter.

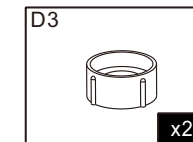
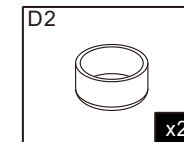
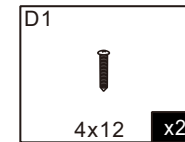
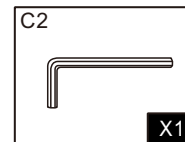
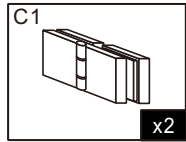
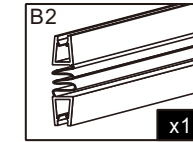
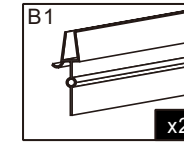
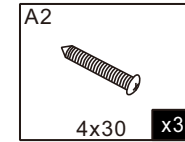
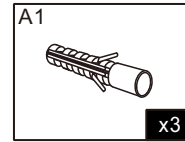
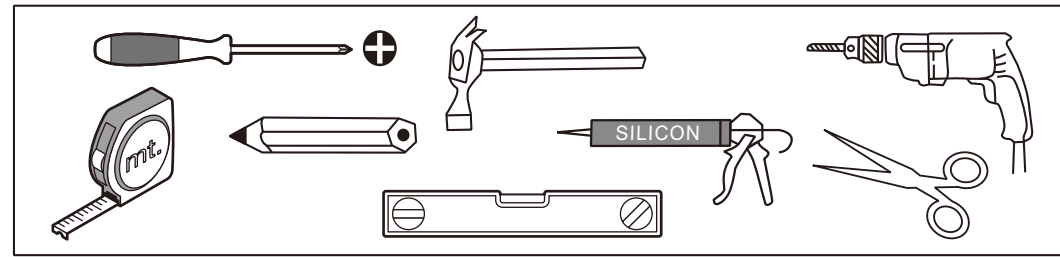
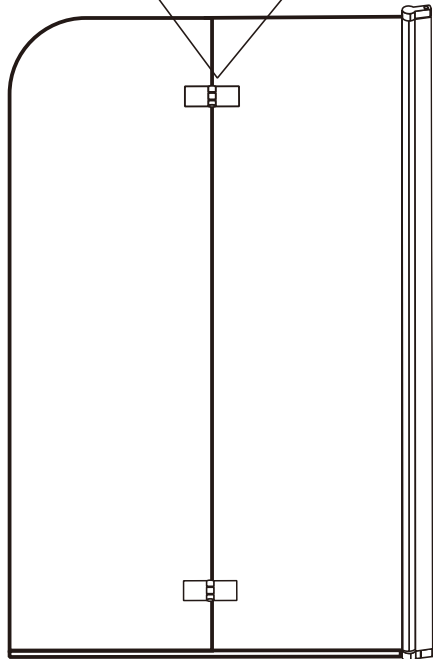
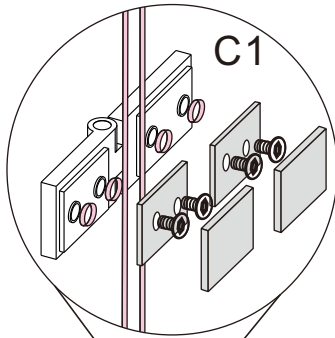
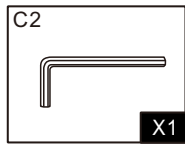
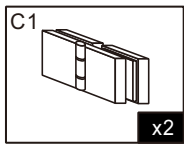

A1: Wall plug for wall

A2: Screw to fix channel to wall

B1: Plastic floor seal on the glass bottom

B2: Plastic seal between two glass panel

C1: Hinges for the glass

C2: Allen key for the hinge

D1: Screw for plastic cap (D3)

D2: Plastic screw cap cover

D3: Plastic screw cap

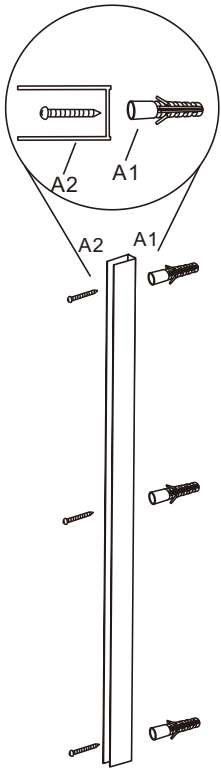
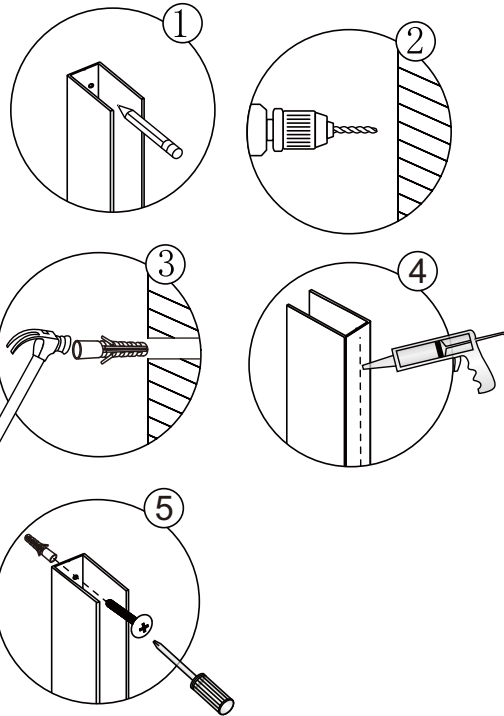
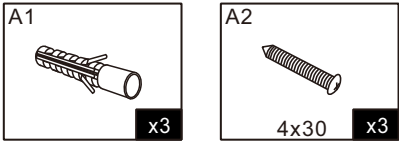
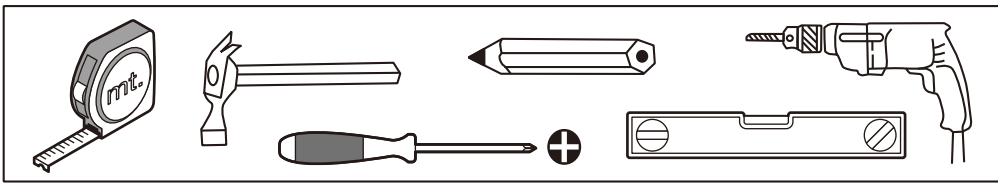

1. Place chanel in correct location and mark hole position.
2. Check for wires, cables, pipes before you drill, if safe go ahead and drill holes
3. Use a rubber Mallet to knock in the plastic plugs known in Australia as (Spagets).
4. Pump Silicon behind the Channel to create a water tight seal.
5. Long as they are Stainless or Galvanized so they don't rust over time

