

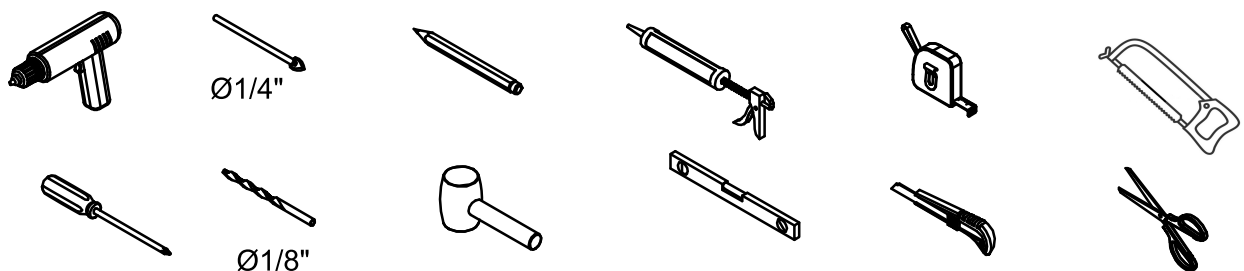

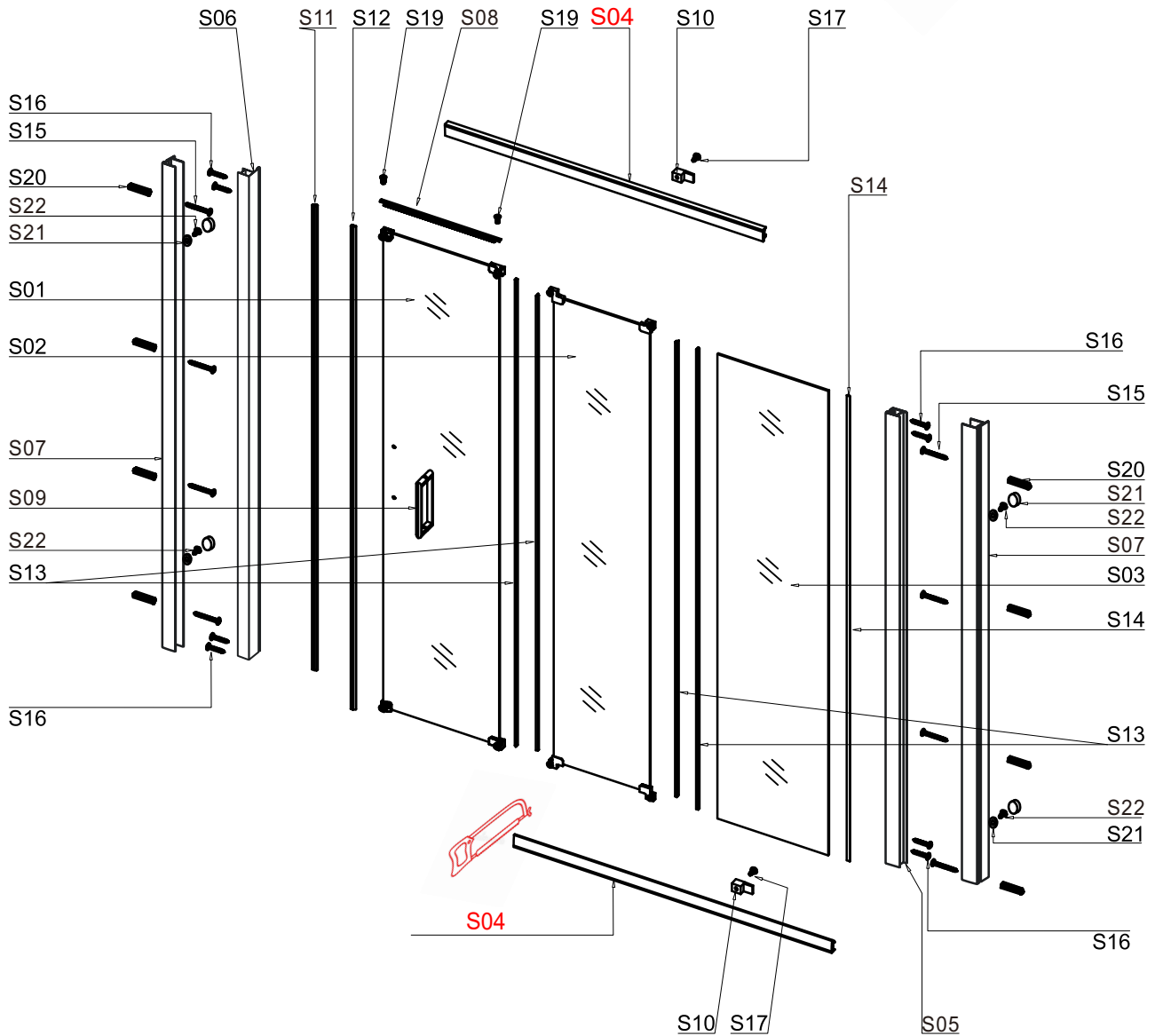







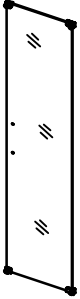

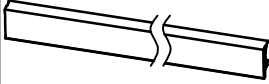
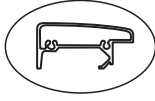



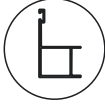



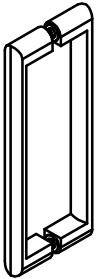
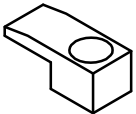



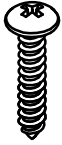

# BELLAVISTA

## Installation Guide

**Model:** SF-F-TD-78-82  
 SF-F-TD-82-86  
 SF-F-TD-86-92\*  
 SF-F-TD-92-102\*  
 SF-F-TD-102-112\*  
 SF-F-TD-112-122\*  
 SF-F-TD-122-132\*

( \* = **S04** Rail needs to be cut to size  )



S01 1PC 	S02 1PC 	S03 1PC 	S04 2PC   Top and bottom Rail	S05 1PC  
S06 1PC  	S07 2PC  	S08 1PC  	S09 1PC 	S10 2PC 
S11 1PC  	S12 1PC  	S13 4PC  	S14 1PC  	S15 8PC ST4X30 
S16 8PC ST4X45 	S17 2PC ST4X12 	S18 1PC   only required for Front and return	S19 2PC M4X8 	S20 8PC Ø6 
S21 8PC 	S22 8PC ST4X12 			

S01: DOOR GLASS PANEL WITH HANDLE HOLE (WHEELS ALREADY INSTALLED)
S02: MIDDLE DOOR GLASS PANEL (WHEELS ALREADY INSTALLED)
S03: FIXED PANEL
S04: ALUMINUM RAIL FOR TOP AND BOTTOM
S05: ALUMINUM PROFILE FOR FIXED PANEL
S06: ALUMINUM CHANNEL FOR DOOR MAGNETIC SEAL
S07: WALL CHANNEL
S08: ALUMINUM CONNECTING PART FOR S01 AND S02
S09: DOOR HANDLE
S10: FIXED PANEL BLOCK
S11: DOOR MAGNETIC SEAL FOR S06
S12: DOOR MAGNETIC SEAL FOR S01
S13: PLASTIC SEAL FOR BETWEEN GLASS
S14: PLASTIC SEAL FOR FIXED PANEL AND ALUMINUM
S15: SCREWS FOR FIXING S07 TO WALL
S16: SCREWS FOR FIXING TOP AND BOTTOM TO S05
S17: SCREWS FOR FIXED PANEL BLOCK
S18: CORNER CONNECTOR IF USING RETURN PANEL (FRONT AND RETURN) OTHERWISE BIN IT
S19: SCREWS FOR S08
S20: SCREW PLUG FOR WALL CHANNEL
S21: PLASTIC SCREW CAP
S22: SCREWS FOR LOCK S05 AND S07

R

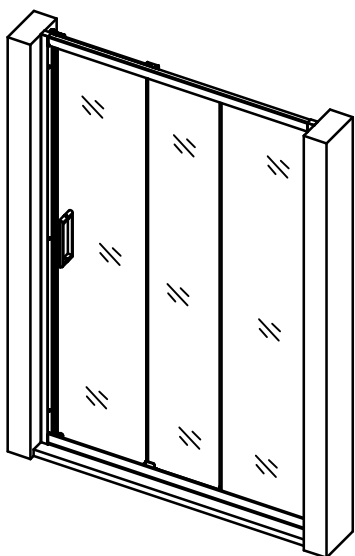

L

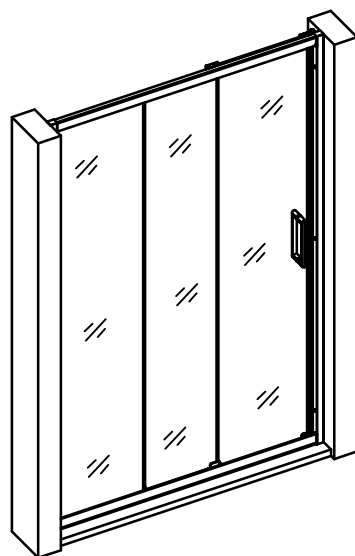

1

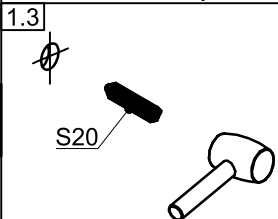
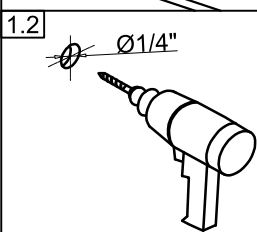
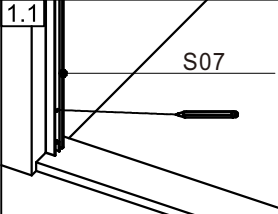
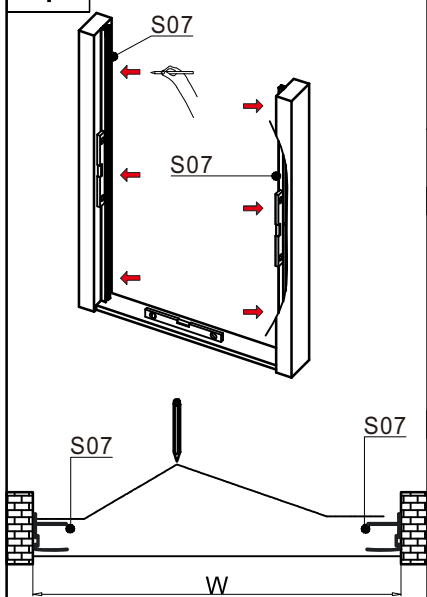

2

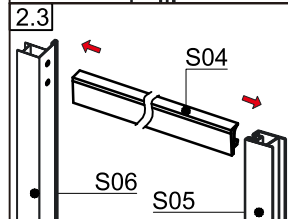
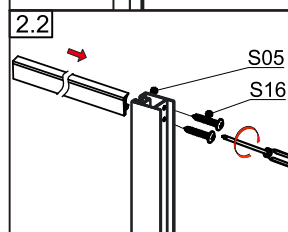
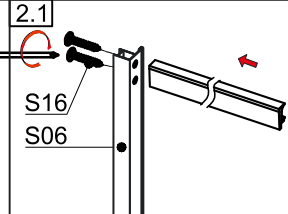
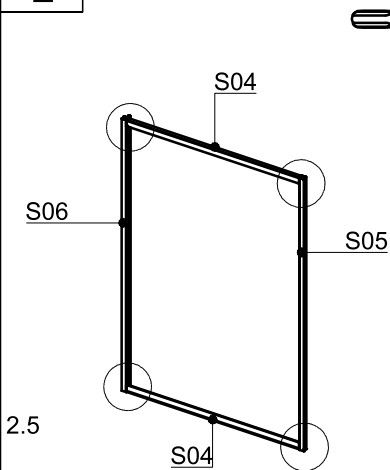

3

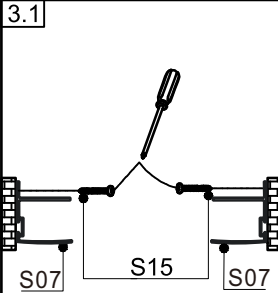
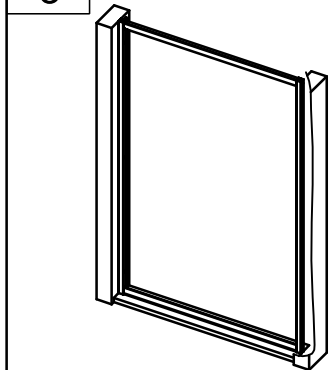

4

